

FEMALE Housing

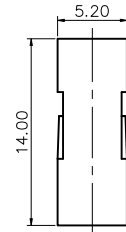

FEMALE TERMINAL

Wire Range		O.D of Wire
Section Area (mm ²)	AWG#	mm
0.09~0.3	28~22	1.2~1.6

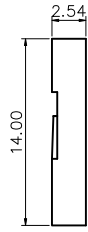
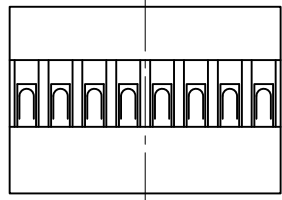
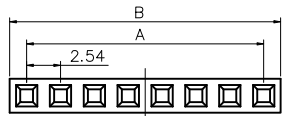
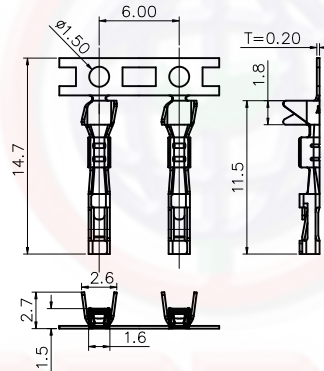

REV.	DESCRIPTION	DRAWN	CHECKED	APPROVED
A	NEW RELEASE	LJH 06/28/05'		LJC 06/28/05'
B	UPDATE DRAWING	JLZ 03/03/16'	HZW 03/03/16'	LJC 03/03/16'

NOTES:

1. MAIN SPECIFICATIONS

- . Housing material: NYLON 66
- . Wire range: AWG#28~#22
- . Rated voltage: 250V
- . Rated current: 3A
- . Contact resistance: ≤ 30mΩ
- . Insulation resistance: ≥ 1000MΩ
- . Withstanding voltage: 500V, AC 1 minute
- . Temperature range: -25 ~ +85°C
- . Recommend PC board thickness: 1.6mm

2. PRODUCT NUMBER CODE:

Position	DIMENSION	
	A	B
1	-	2.54
2	2.54	5.08
3	5.08	7.62
4	7.62	10.16
5	10.16	12.70
6	12.70	15.24
7	15.24	17.78
8	17.78	20.32
9	20.32	22.86
10	22.86	25.40
11	25.40	27.94
12	27.94	30.48
13	30.48	33.02
14	33.02	35.56
15	35.56	38.10

I - DS1071 - S C X 0 XX
 (For Female Housing Only)

— Housing Number
 1*1~1*40
 2*2~2*40

— Housing Color
 B: Black

T - DS1071 - S C X 0 0
 (For Female Terminal Only)

— Contact Plating
 6: Tin
 8: Full gold flash

MALE PRODUCT NUMBER CODE
 SEE DS1021&DS1022

MALE V/T TYPE

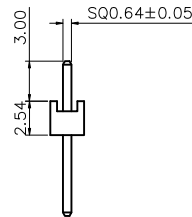
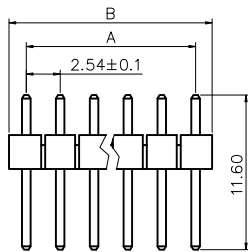

MALE R/A TYPE

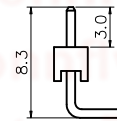
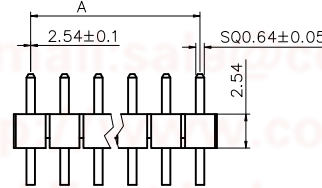
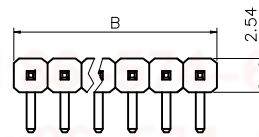

GENERAL TOLERANCE		ANGLE TOLERANCE		PROJECTION	TITLE
X.	±0.60	X.	±5°	mm	P.C.B CONNECTOR 2.54mm TJC8 TYPE
.X	±0.38	.X	±3°	A4	
.XX	±0.25	.XX	±2°	SHEET SIZE	SERIES DS1071 SERIES
DRAWING TYPE		CUSTOMER		晨翔电子有限公司 CONNLY CONNLY ELECTRONIC CO. LTD	
SCALE		1:1 SHEET 1 OF 1			
DRAWING NO.		C-DS1071-XXXXX-B			