

The information provided herein is from CONNELY Electronic Co., Ltd. and is confidential. Any disclosure to a party other than the recipient is prohibited. The intellectual properties and its rights contained herein, including but not limited to, trademarks, patents, copyrights, trade secrets, and technical know-how, are owned exclusively by CONNELY or its affiliates. Unauthorized use or reproduction of any part of this document is strictly prohibited. CONNELY may enforce its intellectual property rights at its own discretion, failures or delays in exercise of such rights does not constitute a waiver of such rights.

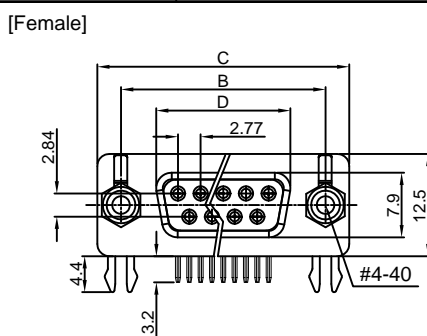

Dimension

Position	A±0.2	B±0.2	C±0.3	D
9	17.90	24.99	30.84	16.33
15	26.50	33.32	39.14	24.66
25	40.00	47.04	53.04	38.38
37	56.50	63.50	69.32	54.84

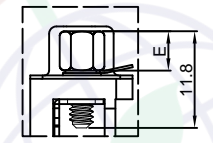
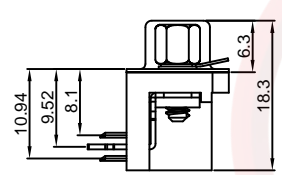
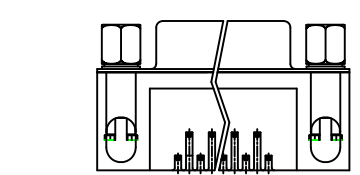

With screw type

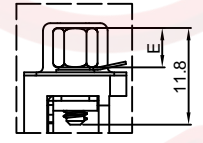
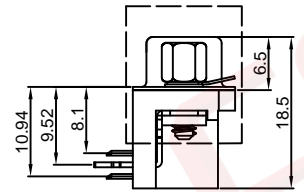
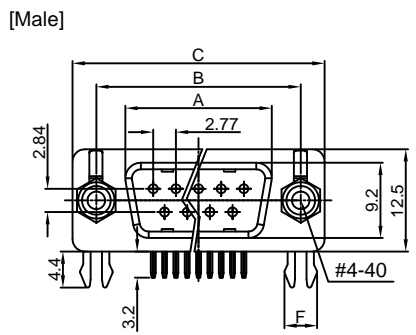

With screw and rivet type

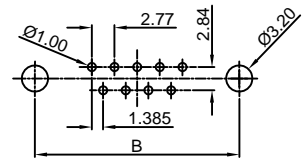

Recommend PCB layout (Tolerance:±0.05)



(Series Image-Reference Only)

REV.	DESCRIPTION	DRAWN	CHECKED	APPROVED
A	NEW RELEASE	YCH 08/13/07'		LJC 08/13/07'
C	DRAWING UPDATE	JLZ 10/07/20'		

NOTES:

- Electrical characteristics:
 - Contact resistance: 20mΩ Max. Initial.
 - Dielectric withstanding voltage: 500V AC(rms) for 1 minute.
 - Insulation resistance: 1000MΩ Min.
- Environment characteristics:
 - Temperature range: -40°C~+105°C.
- Materials:
 - Insulator:PBT+Glass fiber
 - Shell:Steel
 - Contact:Copper alloy
- Product number code:

DS1037 - 02 - X X X X X X X - OCC

- Screw DIM. E
4: 4.80mm 5: 5.80mm
- Board lock DIM. F
7: 3.70mm
- Contact plating
T: Selective gold flash
Si: Full gold flash
- Color of housing
K: Black
- Screw type
A: With screw type
C: With screw and rivet type
- Shell plating
N: Nickel
- Connector type
M: Male F: Female
- No. of contact
09,15,25,37

GENERAL TOLERANCE		ANGLE TOLERANCE		PROJECTION		TITLE	
X.	±0.60	X.	±5°	UNITS	mm	D-SUB R/A(7.2mm) With Shielding Type	
.X	±0.38	.X	±3°	SHEET SIZE	A4	SERIES	DS1037-02 SERIES
.XX	±0.25	.XX	±2°	晨翔电子有限公司 CONNFLY CONNFLY ELECTRONIC CO. LTD			
DRAWING TYPE		CUSTOMER					
SCALE		1:1					
DRAWING NO.		C-DS1037-02-XXXXXXX-OCC-B		SHEET		1 OF 1	