

The information provided herein is from CONNELY Electronic Co., Ltd. and is confidential. Any disclosure to a party other than the recipient is prohibited. The intellectual properties and its rights contained herein, including but not limited to, trademarks, patents, copyrights, trade secrets, and technical know-how, are owned exclusively by CONNELY or its affiliates. Unauthorized use or modification is strictly prohibited. CONNELY may enforce its intellectual property rights at its own discretion; failures or delays to exercise such rights does not constitute a waiver of such rights.

1 2 3 4 5 6 7 8

Dept	Qty
DC	1
ED	1
IE	1
ISO	1
PD	1
R&D	1
SD	1
QA	1
QC	1
QE	1

REV.	DESCRIPTION	DRAWN	CHECKED	APPROVED
A	NEW RELEASE	LL 23/06/05		LJC 23/06/05'
B	DRAWING UPDATE	JLZ 08/24/16'	HZW 08/24/16'	LJC 08/24/16'
D	DRAWING UPDATE	JLZ 01/16/19'		

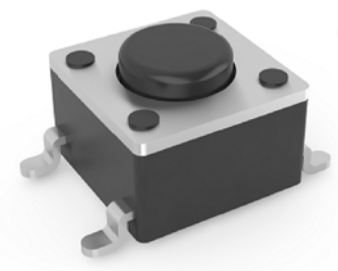
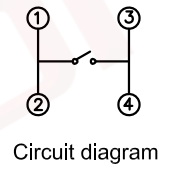
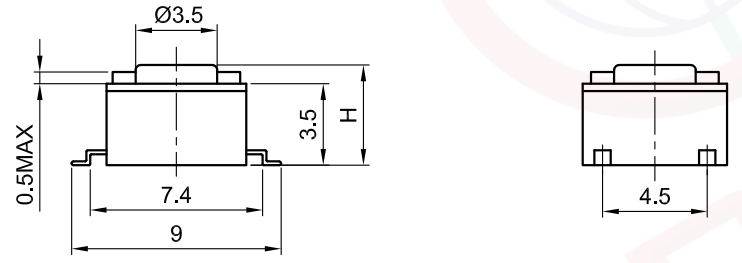
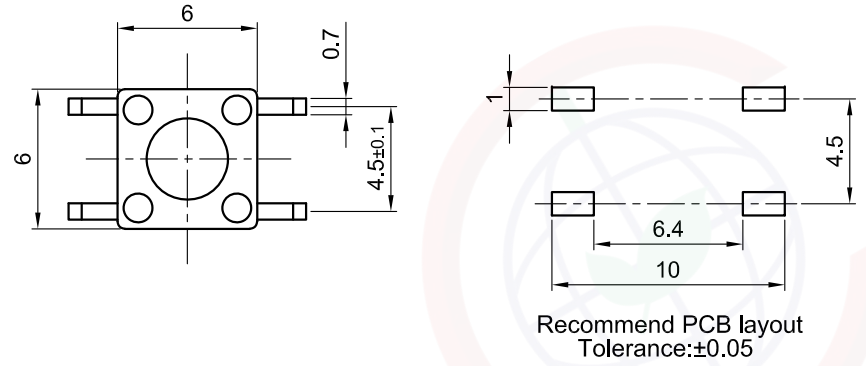

(Series Image-Reference Only)

NOTES:

- Specifications
 - Switch Function: Single Pole Single Throw
 - Contact Rating: 50mA at 12Vdc
 - Insulation Resistance: 100MΩ min.
 - Contact Resistance: 100mΩ max.
 - Operating Life: 100,00 cycles
 - Stop Strength: Place The Switch Such That Vertical, A Static Load Of 3Kgf Shall Be Applied In The Direction
 - Operation Temperature Range: -25°C to +70°C
 - Wave Soldering: Recommended Solder Temperature At 500°F(260°C)max. 5 Seconds, Subject To PCB 1.6mm Thickness.
 - Hand Soldering: Use Soldering Iron Of 30 Watts, Controlled At 608°F(320°C) Approximately 2 Seconds.
- Product number code:

DS1042-03	-	X	X	X	X	X	X	X	X
-----------	---	---	---	---	---	---	---	---	---

 - Operating Life
 - 5: 50000 cycles 10: 100000 cycles
 - 20: 200000 cycles 30: 300000 cycles
 - Operating Force
 - 130: 130gf 160: 160gf
 - 170: 170gf 250: 250gf 320: 320gf
 - Packing Type
 - A: Polybag B: Tube
 - R: Tape & Reel
 - Actuator Color
 - K: Black N: Brown E: Salmon
 - Housing Color
 - K: Black N: Brown
 - Profile Height(DIM. H)
 - 1: 4.3mm 2: 5.0mm 3: 7.0mm 4: 7.3mm
 - 5: 9.5mm 6: 13.0mm 7: 7.5mm 8: 8.0mm
 - 9: 8.5mm 10: 12.0mm 11: 12.5mm 12: 17.0mm
 - 13: 7.8mm 14: 9.0mm 15: 10.0mm 16: 11.0mm
 - 17: 15.0mm 18: 5.3mm 19: 5.5mm 20: 6.0mm
 - 21: 10.5mm 22: 14.0mm 23: 16.0mm
 - Size
 - 1: 6mm*6mm

GENERAL TOLERANCE		ANGLE TOLERANCE		PROJECTION		TITLE	TACT SWITCH SMT TYPE 6mmX6mm	
X.	±0.60	X.	±5°	UNITS	mm	SHEET	A4	
.X	±0.38	.X	±3°	SHEET SIZE	A4	SERIES	DS1042-03 SERIES	
.XX	±0.25	.XX	±2°			晨翔电子有限公司 CONNELY ELECTRONIC CO. LTD		
DRAWING TYPE		CUSTOMER						
SCALE		1:1	SHEET	1 OF 3				
DRAWING NO.		C-DS1042-03-1XXXXXX-D						

1 2 3 4 5 6 7 8

Dept	Qty
DC	1
ED	1
IE	1
ISO	1
PD	1
R&D	1
SD	1
QA	1
QC	1
QE	1

The information provided herein is from CONNELY Electronic Co., Ltd. and is confidential. Any disclosure to a party other than the recipient is prohibited. The intellectual properties and its rights contained herein, including but not limited to, trademarks, patents, copyrights, trade secrets, and technical know-how, are owned exclusively by CONNELY or its affiliates. Unauthorized use or modification is strictly prohibited. CONNELY may enforce its intellectual property rights at its own discretion, failure or delays to exercise such rights does not constitute a waiver of such rights.

REV.	DESCRIPTION	DRAWN	CHECKED	APPROVED
A	NEW RELEASE	LL 23/06/05		LJC 23/06/05'
B	DRAWING UPDATE	JLZ 08/24/16'	HZW 08/24/16'	LJC 08/24/16'
D	DRAWING UPDATE	JLZ 01/16/19'		

NOTES:

- Specifications
 - Switch Function: Single Pole Single Throw
 - Contact Rating: 50mA at 12Vdc
 - Insulation Resistance:100MΩ min.
 - Contact Resistance:100mΩ max.
 - Operating Life:100,00 cycles
 - Stop Strength: Place The Switch Such That Vertical, A Static Load Of 3Kgf Shall Be Applied In The Direction
 - Operation Temperature Range: -25°C to +70°C
 - Wave Soldering: Recommended Solder Temperature At 500°f(260°C)max. 5 Seconds,Subject To PCB 1.6mm Thickness.
 - Hand Soldering: Use Soldering Iron Of 30 Watts,Controlled At 608°f(320°C)Approximately 2 Seconds.
- Product number code:

DS1042-03 - X X X X X X

 - Operating Life
 - 5: 50000 cycles
 - 10: 100000 cycles
 - 20: 200000 cycles
 - Operating Force
 - 130: 130gf
 - 160: 160gf
 - 170: 170gf
 - 250: 250gf
 - Packing Type
 - A: Polybag
 - B: Tube
 - R: Tape & Reel
 - Actuator Color
 - K: Black
 - N: Brown
 - Housing Color
 - K: Black
 - N: Brown
 - Profile Height(DIM. H)
 - 1:4.3mm
 - 2:5.0mm
 - 3:7.0mm
 - 4:7.3mm
 - 5:9.5mm
 - 6:13.0mm
 - 7:7.5mm
 - 8:8.0mm
 - 9:8.5mm
 - 10:12.0mm
 - 11:12.5mm
 - 12:17.0mm
 - 13:7.8mm
 - 14:9.0mm
 - 15:10.0mm
 - 16:11.0mm
 - 17:15.0mm
 - 18:5.3mm
 - 19:5.5mm
 - Size
 - 2: 3mm*6mm

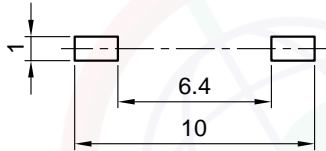
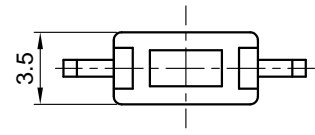

Recommend PCB layout
Tolerance±0.05

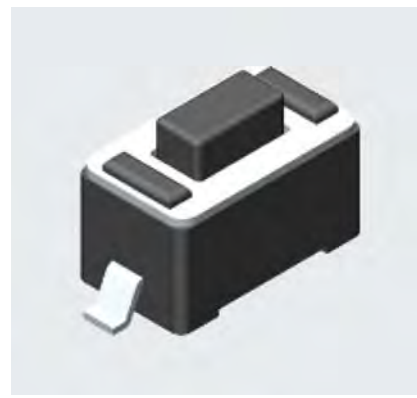
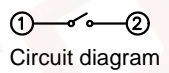
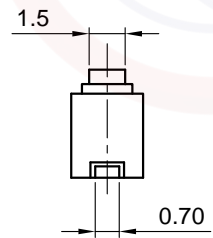
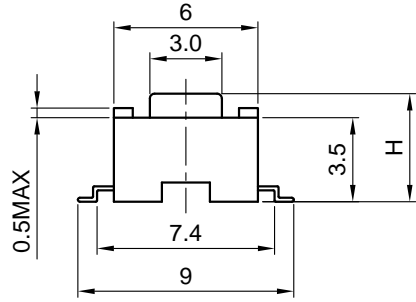

(Series Image-Reference Only)

GENERAL TOLERANCE		ANGLE TOLERANCE		PROJECTION		TITLE	TACT SWITCH SMT TYPE 3.5mmX6mm	
X.	±0.60	X.	±5°	UNITS	mm			
.X	±0.38	.X	±3°	SHEET SIZE	A4	SERIES	DS1042-03 SERIES	
.XX	±0.25	.XX	±2°	晨翔电子有限公司 CONNELY ELECTRONIC CO., LTD				
DRAWING TYPE		CUSTOMER						
SCALE	1:1	SHEET	2 OF 3					
DRAWING NO.		C-DS1042-03-2XXXXXX-D						

Dept	
Qty	
DC	1
ED	1
IE	1
ISO	1
PD	1
R&D	1
SD	1
QA	1
QC	1
QE	1

The information provided herein is from CONNELY Electronic Co., Ltd. and is confidential. Any disclosure to a party other than the recipient is prohibited. The intellectual properties and its rights contained herein, including but not limited to, trademarks, patents, copyrights, trade secrets, and technical know-how, are owned exclusively by CONNELY or its affiliates. Unauthorized use or modification is strictly prohibited. CONNELY may enforce its intellectual property rights at its own discretion, failure or delays to exercise such rights does not constitute a waiver of such rights.

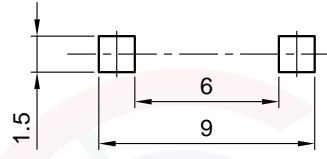
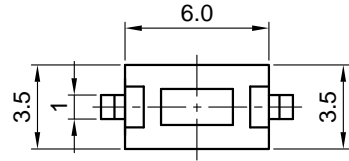

Recommend PCB layout
Tolerance±0.05

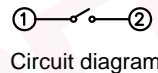
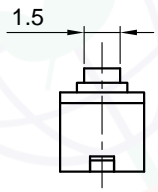
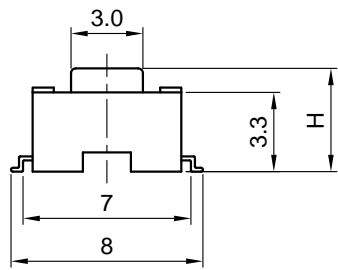

(Series Image-Reference Only)

REV.	DESCRIPTION	DRAWN	CHECKED	APPROVED
A	NEW RELEASE	LL 23/06/05		LJC 23/06/05'
B	DRAWING UPDATE	JLZ 08/24/16'	HZW 08/24/16'	LJC 08/24/16'
D	DRAWING UPDATE	JLZ 01/16/19'		

NOTES:

- Specifications
 - Switch Function: Single Pole Single Throw
 - Contact Rating: 50mA at 12Vdc
 - Insulation Resistance:100MΩ min.
 - Contact Resistance:100mΩ max.
 - Operating Life:100,00 cycles
 - Stop Strength: Place The Switch Such That Vertical, A Static Load Of 3Kgf Shall Be Applied In The Direction
 - Operation Temperature Range: -25°C to +70°C
 - Wave Soldering: Recommended Solder Temperature At 500°f(260°C)max. 5 Seconds,Subject To PCB 1.6mm Thickness.
 - Hand Soldering: Use Soldering Iron Of 30 Watts,Controlled At 608°f(320°C)Approximately 2 Seconds.
- Product number code:

DS1042-03 -	X	X	X	X	X	X	
	Operating Life	5: 50000 cycles	10: 100000 cycles	20: 200000 cycles	Operating Force	130: 130gf	160: 160gf
					170: 170gf	250: 250gf	
	Packing Type	A: Polybag	B: Tube		R: Tape & Reel		
	Actuator Color	K: Black	N: Brown				
	Housing Color	K: Black	N: Brown				
	Profile Height(DIM. H)	1: 4.3mm	2: 5.0mm	3: 7.0mm	4: 7.3mm	5: 9.5mm	6: 13.0mm
		7: 7.5mm	8: 8.0mm	9: 8.5mm	10: 12.0mm	11: 12.5mm	12: 17.0mm
		13: 7.8mm	14: 9.0mm	15: 10.0mm	16: 11.0mm	17: 15.0mm	18: 5.3mm
		19: 5.5mm					
	Size	3: 3.5mm*6mm					

GENERAL TOLERANCE	ANGLE TOLERANCE	PROJECTION		TITLE	TACT SWITCH SMT TYPE 3.5mmX6mm	
X. ±0.60	X. ±5°	UNITS	mm			
.X ±0.38	.X ±3°	SHEET SIZE	A4	SERIES	DS1042-03 SERIES	
.XX ±0.25	.XX ±2°	晨翔电子有限公司 CONNFLY CONNELY ELECTRONIC CO. LTD				
DRAWING TYPE	CUSTOMER					
SCALE	1:1					
DRAWING NO.	C-DS1042-03-3XXXXXX-D					